



LYNK LITE

Communication Gateway

805-0059 LYNK LITE Victron (Mobile) Manual

READ AND SAVE THESE INSTRUCTIONS



- 1. AUDIENCE, SAFETY, MESSAGES, AND WARNINGS 3**
 - 1.1 Audience 3
 - 1.2 Warning, Caution, Notice, and Note Messages 3
 - 1.3 General Warnings 4
 - 1.4 Safe Handling Procedures 4
 - 1.5 Personal Protective Equipment 5
- 2. DOCUMENTATION 5**
- 3. OVERVIEW 5**
 - 3.1 System Overview 6
 - 3.2 Compatibility 7
 - 3.3 Minimum Battery System Capacity 8
- 4. INSTALLATION AND CONNECTING LYNK LITE TO THE VE.CAN NETWORK 10**
 - 4.1 Networking Discover Lithium Batteries with LYNK LITE 10
 - 4.2 Connecting LYNK LITE to the VE.CAN Network 11
- 5. ENABLING LYNK LITE TO COMMUNICATE WITH VICTRON DEVICES 12**
 - 5.1 Victron Open-Loop Configuration 13
 - 5.2 Setting Victron as the LYNK LITE Communication Protocol 17
 - 5.3 Victron Closed-Loop Configuration 18
 - 5.4 Configurable Closed-Loop Settings 19

INTRODUCTION

This Application Note provides information about integrating LYNK and AEBus network-enabled Discover Lithium Batteries using the LYNK LITE Communication Gateway with Victron Mobile inverter-chargers.

1. AUDIENCE, SAFETY, MESSAGES, AND WARNINGS

1.1 Audience

Configuration, installation, service, and operating tasks should only be performed by qualified personnel in consultation with local authorities having jurisdiction and authorized dealers. Qualified personnel should have training, knowledge, and experience in the:

- Installation of electrical equipment
- Application of applicable installation codes
- Analysis and reduction of the hazards involved in performing electrical work
- Installation and configuration of batteries

1.2 Warning, Caution, Notice, and Note Messages

Messages in this manual are formatted according to this structure.

WARNING

Important information regarding hazardous conditions that may result in personal injury or death.

CAUTION

Important information regarding hazardous conditions that may result in personal injury.

NOTICE

Important information regarding conditions that may damage the equipment but not result in personal injury.

NOTE

Ad hoc information concerning important procedures and features not related to personal injury or equipment damage.

1.3 General Warnings

WARNING

ELECTRIC SHOCK AND FIRE HAZARD

- This equipment must only be installed as specified.
- Do not disassemble or modify the battery.
- If the battery case has been damaged, do not touch exposed contents.
- There are no user-serviceable parts inside.

Failure to follow these instructions may result in death or serious injury.

WARNING

ELECTRIC SHOCK AND FIRE HAZARD

Do not lay tools or other metal parts on the battery or across the terminals.

Failure to follow these instructions may result in death or serious injury.

CAUTION

ELECTRIC SHOCK HAZARD

- Do not touch the energized surfaces of any electrical component in the battery system.
- Before servicing the battery, follow all procedures to fully de-energize the battery system.
- Follow the “Safe Handling Procedures” below when working with the battery.

Failure to follow these instructions may result in injury.

1.4 Safe Handling Procedures

Before using the battery and any power electronics, read all instructions and cautionary markings on all components and appropriate sections of their manuals.

- Use personal protective equipment when working with batteries.
- Do not dispose of the battery in a fire.
- Promptly dispose of or recycle used batteries following local regulations.
- Do not disassemble, open, crush, bend, deform, puncture, or shred.
- Do not modify, re-manufacture, or attempt to insert foreign objects into the battery, immerse or expose the battery to water or other liquids, fire, explosion, or other hazards. If the user suspects damage to the battery module due to water, heat, or other reason, take it to a service center for inspection.
- Only use the battery for the system for which it is specified.
- Do not lift or carry the battery while in operation.
- When lifting a heavy battery, follow the appropriate standards.
- Only lift, move, or mount following local regulations.
- Take care when handling battery terminals and cabling.

- Only use the battery with a charging system that meets specifications. Using a battery or charger that does not meet specifications may present a risk of fire, explosion, leakage, or other hazards.
- Do not short-circuit a battery or allow metallic conductive objects to contact battery terminals.
- Replace the battery only with another one qualified for the system. Using an unqualified battery may present a risk of fire, explosion, leakage, or other hazards.
- Do not drop the device or battery. If the device or battery is dropped, especially on a hard surface, and the user suspects damage, take it to a service center for inspection.

1.5 Personal Protective Equipment

When handling or working near a battery:

- Use Personal Protective Equipment, including clothing, glasses, insulated gloves, and boots.
- Do not wear rings, watches, bracelets, or necklaces.

2. DOCUMENTATION

This Application Note provides information about integrating LYNK network-enabled Discover Lithium Batteries using the LYNK LITE Communication Gateway with Victron Mobile inverter-chargers.

Before installation and configuration, consult the relevant product documentation, including Manuals, Application Notes, and Installation and Configuration Guides.

Victron Energy Documentation

Visit <https://www.victronenergy.com/> for the most recent version of published documents.

Discover Battery Documentation

Visit <https://discoverbattery.com> for the most recent version of published documents, including Discover Lithium battery user manuals and the LYNK LITE Installation and Operation Manual (805-0035).

3. OVERVIEW

This manual provides general settings and is not a comprehensive guide to the programming and configuration of a specific installation. An installation may have unique conditions or use cases requiring value modification or adaptations. Installers must be capable of reviewing and adapting to the specifics of an installation and its specific use case and optimizing settings where needed.

The key steps required to install and configure the LYNK LITE Communication Gateway with compatible Discover Lithium batteries and power conversion equipment are as follows:

- Review and confirm equipment compatibility and correct sizing.
- Mount the LYNK LITE, and connect the Discover battery communication network to either the LYNK Port or AEBus Port.
- Match and connect the LYNK LITE CAN out pins to the CAN pins of the power conversion communication network.
- Terminate all networks correctly.
- Set up the open-loop configuration parameters on the power conversion equipment.
- Set the LYNK LITE using LYNK ACCESS software to the correct protocol to enable closed-loop communication between the Discover batteries and the power conversion equipment.
- Set up the closed-loop configuration parameters on the power conversion equipment.
- Set up user preferences and enable the use case using the power conversion control system.

3.1 System Overview

The LYNK LITE Communication Gateway unlocks the full potential of a Discover Lithium battery by enabling the internal Battery Management System (BMS) to provide real-time data in a closed-loop configuration to other devices. This configuration allows hybrid inverter-chargers and solar charge controller systems to optimize control over the charging process. LYNK LITE also enables the remote monitoring of Discover Lithium battery SOC and data logging of multiple sites using the data monitoring services offered by inverter systems.

Discover Lithium batteries must be set up to work with power conversion and monitoring devices in either an open-loop or closed-loop configuration.

In an open-loop configuration, charge and discharge settings are set up manually through the controller for the power conversion device at the installation time.

In a closed-loop configuration, the BMS of the Discover Lithium battery sends the battery status over a network data connection with the power conversion device. Power conversion devices use the Discover Lithium battery BMS data to finetune the output of their charger and deliver other functional controls based on battery voltage, temperature, and percent State-of-Charge.

If communication is interrupted between the BMS and Victron inverter-charger, the Victron inverter-charger uses the charge and discharge settings specified for an open-loop configuration.

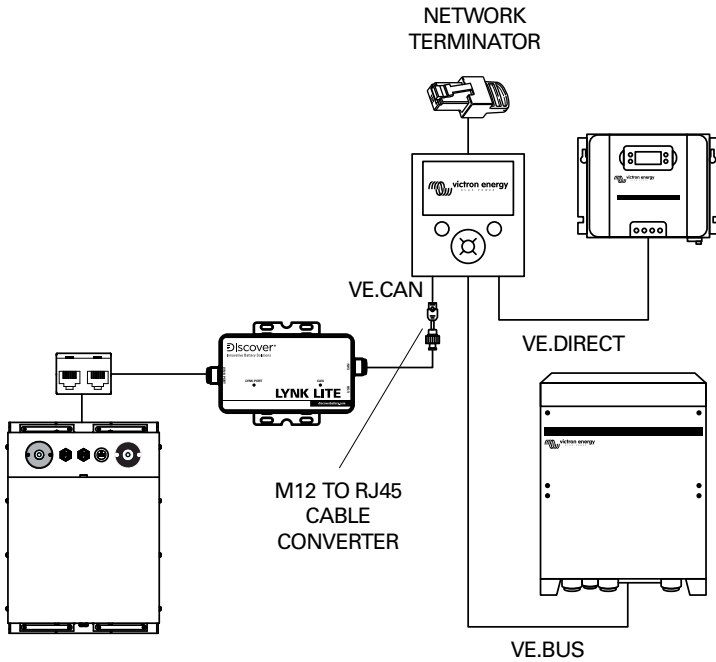

Figure 1. Example LYNK LITE with Victron Energy devices

3.2 Compatibility

The LYNK LITE Communication Gateway is compatible with the following:

Discover Lithium Batteries

- LITHIUM PROFESSIONAL: DLP-GC2-12V, DLP-GC2-24V, DLP-GC2-48V
- AES LiFePO₄: 12-48-6650, 14-48-3000, 14-24-2800

Victron Products

Control Panels:

- Cerbo GX
- Color Control GX
- Venus GX

Used in conjunction with:

- Quattro Inverter-Charger
- Multiplus Inverter-Charger
- SmartSolar MPPT

3.3 Minimum Battery System Capacity

Battery charge and discharge rates are managed automatically by the Discover Lithium Battery and Victron Energy device. Using large solar arrays with battery banks that are too small can exceed the operating limits of the battery to charge and possibly lead to the BMS triggering over-current protection. Either curtail the charging below the operational limit of installed batteries, or the battery capacity must accept the maximum charge current of the system. Derive this value by adding the charge capacities of all inverter-chargers and solar charge controllers in the system. Additionally, battery peak capacity must support the surge requirements demanded by the load attached to the inverter. Match all inverter peak power values with the sum of all battery peak current values.

$$\text{Inverter Peak Amps DC} = (\text{Inverter Surge W}) / (\text{Inverter Efficiency}) / (48\text{V: Low Battery Cut-Off})$$

$$\text{Discharge Continuous Amps DC} = (\text{Inverter Continuous W}) / (\text{Inverter Efficiency}) / (48\text{V: Low Battery Cut-Off})$$

48V 120 Vac Models	Inverter Peak Amps DC	Discharge Continuous Max Amps DC	Charger Continuous Max Amps DC	12-48-6650 Minimum per inverter	14-48-3000 Minimum per inverter	DLP-GC2-48V Minimum per inverter
MultiPlus 48/2000/25-50 (1)	77	35	25	1	1	2
MultiPlus-II 48/3000/35-50 (2)	122	53	35	1	1	2
Quattro 48/3000/35-50/50 120V (3)	132	53	35	1	1	2
Quattro 48/5000/70-100/100 120V (4)	220	88	35	1	2	3

1 Calculated based on max 3500W at 120 VAC peak output, 1600W at 120VAC continuous output, efficiency 95.0 %, and 25A DC max charging, as published in Victron Multiplus 2kVA 120A Manual rev 05 - 01/2022.

2 Calculated based on max 5500W at 120 VAC peak output, 2400W at 120VAC continuous output, efficiency 94.0 %, and 35A DC max charging, as published in Victron MultiPlus-II 12V/24V/48V 3kVA 120V Rev 02 09/2022.

3 Calculated based on max 2400W at 120 VAC peak output, 6000W at 120VAC continuous output, efficiency 95.0 %, and 35A DC max charging, as published in Victron Quattro (with firmware xxxx400 or higher) 48/3000/35-50/50 120V Version 14, 08-04-2020.

4 Calculated based on max 4000W at 120 VAC peak output, 10000W at 120VAC continuous output, efficiency 95.0 %, and 70 A DC max charging, as published in Victron Quattro (with firmware xxxx400 or higher) 48/5000/70-100/100 120V Version 7, 08-05-2020.

Inverter Peak Amps DC = (Inverter Surge W) / (Inverter Efficiency) / (24V: Low Battery Cut-Off)

Discharge Continuous Amps DC = (Inverter Continuous W) / (Inverter Efficiency) / (24V: Low Battery Cut-Off)

24V 120 Vac Models	Inverter Peak Amps DC	Discharge Continuous Max Amps DC	Charger Continuous Max Amps DC	14-24-2800 Minimum per inverter	DLP-GC2-24V Minimum per inverter
MultiPlus 24/2000/50-50 (1)	155	71	50	1	1
MultiPlus-II 24/3000/70-50 (2)	244	107	70	1	2
MultiPlus-II 2x120V 24/3000/70-50 (3)	244	107	70	1	2
Quattro 24/5000/120-100/100 120V (4)	222	87	120	2	2

¹ Calculated based on max 3500W at 120 VAC peak output, 1600W at 120VAC continuous output, efficiency 94.0 %, and 50A DC max charging, as published in Victron Multiplus 2kVA 120V Manual Rev 05 - 01/2022.

² Calculated based on max 5500W at 120 VAC peak output, 2400W at 120VAC continuous output, efficiency 94.0 %, and 70 A DC max charging, as published in Victron MultiPlus-II 12V/24V/48V 3kVA 120V Rev 02 09/2022.

³ Calculated based on max 5500W at 120 VAC peak output, 2400W at 120VAC continuous output, efficiency 94.0 %, and 70A DC max charging, as published in Victron MultiPlus-II 12V/24V 3kVA 2x120V Rev 06 08/2022.

⁴ Calculated based on max 4000W at 120 VAC peak output, 10000W at 120VAC continuous output, efficiency 94.0 %, and 120A DC max charging, as published in Victron Quattro (with firmware xxxx400 or higher) 24/5000/120-100/100 120V Version 7, 08-05-2020.

Inverter Peak Amps DC = (Inverter Surge W) / (Inverter Efficiency) / (12V: Low Battery Cut-Off)

Discharge Continuous Amps DC = (Inverter Continuous W) / (Inverter Efficiency) / (12V: Low Battery Cut-Off)

12V 120 Vac Models	Inverter Peak Amps DC	Discharge Continuous Max Amps DC	Charger Continuous Max Amps DC	DLP-GC2-12V Minimum per inverter
MultiPlus 12/2000/80 (1)	314	144	80	2
MultiPlus 12/3000/120-50 (2)	493	215	120	3
MultiPlus 12/3000/120-50 2x 120 (3)	493	215	120	3
Quattro 12/5000/220-100/100 120V (4)	887	355	200	5

¹ Calculated based on max 3500W at 120 VAC peak output, 1600W at 120VAC continuous output, efficiency 93.0 %, and 80A DC max charging, as published in Victron MultiPlus 2kVA 120V rev 05 - 01/2022.

² Calculated based on max 5500W at 120 VAC peak output, 2400W at 120VAC continuous output, efficiency 93.0 %, and 120A DC max charging, as published in Victron MultiPlus-II 12V/24V 3kVA 2x120V Rev 06 08/2022.

³ Calculated based on max 5500W at 120 VAC peak output, 2400W at 120VAC continuous output, efficiency 93.0 %, and 120A DC max charging, as published in Victron MultiPlus-II 12V/24V/48V 3kVA 120V Rev 02 09/2022.

⁴ Calculated based on max 4000W at 120 VAC peak output, 10000W at 120VAC continuous output, efficiency 94.0 %, and 200A DC max charging, as published in Victron Quattro (with firmware xxxx400 or higher) 12/5000/220-100/100 120V Version 7, 08-05-2020.

4. INSTALLATION AND CONNECTING LYNK LITE TO THE VE.CAN NETWORK

4.1 Networking Discover Lithium Batteries with LYNK LITE

NOTICE

- Turn OFF all devices before connecting cables.
- Mixing the LYNK Network with other networks may result in equipment malfunction and damage.

NOTICE

Unless specified by Discover Battery, do not connect power electronics directly to the LYNK network or AEBus network.

Refer to the LYNK LITE Installation and Operation Manual (805-0035) for instructions on network layouts, connections, and terminators of compatible Discover Lithium battery models. Some key points are repeated here for convenience.

- Connect at least one battery to the LYNK Port on the LYNK LITE.
- A network of batteries will communicate as one battery.
- Connect no more than one network of batteries to the LYNK LITE.
- Proper system function requires network termination – some batteries and devices may auto-terminate.
- LYNK LITE requires power from one of two possible sources (an AEBus/LYNK Port-enabled Discover Lithium battery or a USB device).
- Discover Lithium batteries must be set to ON to supply power and communicate with LYNK LITE.

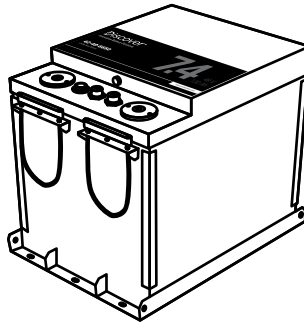

Figure 2. AES LiFePO₄ Mobile Industrial Battery

The LYNK LITE is internally terminated. AES batteries are not internally terminated. When using LYNK LITE on an AESbus or LYNK network, install a terminator opposite the LYNK LITE at the far end of the battery network.

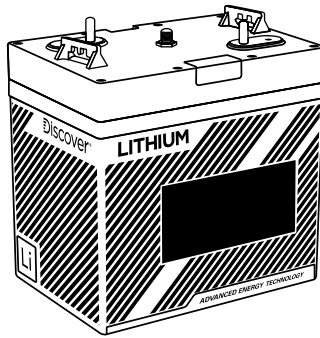

Figure 3. LITHIUM PROFESSIONAL Battery

LYNK LITE and LITHIUM PROFESSIONAL batteries are both internally terminated. No external termination is required when installing the LYNK LITE with LITHIUM PROFESSIONAL batteries.

4.2 Connecting LYNK LITE to the VE.CAN Network

Ensure that the Victron GX device uses firmware version 2.89 or later before connecting LYNK LITE to the VE.CAN network. Also, ensure the LYNK LITE is configured correctly in the LYNK Access configuration software.

The LYNK LITE CAN out port is an M12 A-Code circular metric connector and the VE.CAN port on the Victron device is an RJ45 connector. An adapter cable is required for the LYNK LITE to connect to the VE.CAN network. Use the optional accessory 950-0060 available from Discover Battery, or make your own. See the diagram below for the proper pin configurations.

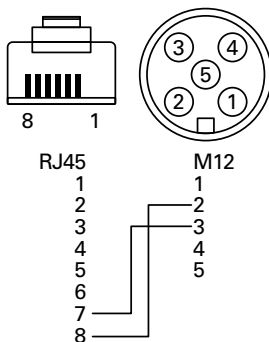

Figure 4. Pin adapter configuration

Attach the M12 connector to the LYNK LITE CAN out port, and insert the RJ45 connector into one of the two VE.CAN ports (A or B) on the back of the Victron device. As the LYNK LITE is internally terminated, the external terminator provided with the GX is not required.

NOTE

Ensure the Victron GX device is using firmware version 2.89 or later.

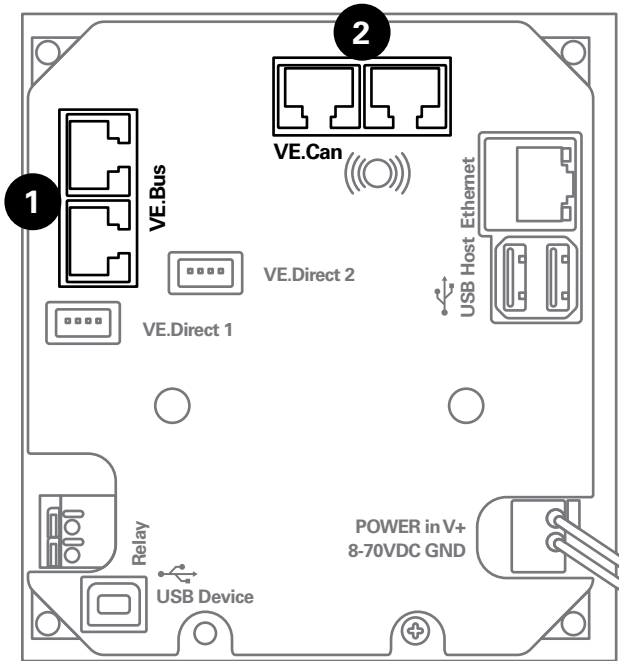

Figure 5. Victron GX Device

1. VE.BUS: CAT5 socket for connecting to the Victron inverter.
2. VE.CAN: CAT5 socket for connection to LYNK LITE CAN out.
 - Insert a terminator in the other VE.CAN port to terminate the network with the LYNK LITE.

5. ENABLING LYNK LITE TO COMMUNICATE WITH VICTRON DEVICES

When the LYNK LITE is in a closed-loop network using the CANopen protocol, LYNK LITE will transmit real-time parameters from the Discover Lithium battery, including voltage, current, temperature, state of charge, and fault conditions to a Victron device. LYNK LITE also transmits charge voltage and current requests from the Discover Lithium battery to the Victron device.

The Victron inverter-charger defaults to open-loop (voltage-based) settings when there is a break in communication with LYNK LITE. Therefore, as a precautionary measure, it is recommended to program the Victron inverter-charger with the correct voltage-based parameters before setting up the system to operate in a closed-loop configuration.

LYNK ACCESS software for 64-bit Windows 10 is required to configure LYNK LITE settings for closed-loop CAN communication with Victron devices.

5.1 Victron Open-Loop Configuration

You will need the latest firmware on all connected devices. The following presumes familiarity with VE Configure 3 software. After setting the voltage-based open-loop parameters using the VE Configure 3 software, 'send' all parameters to the inverter-charger and GX device and then restart the GX device.

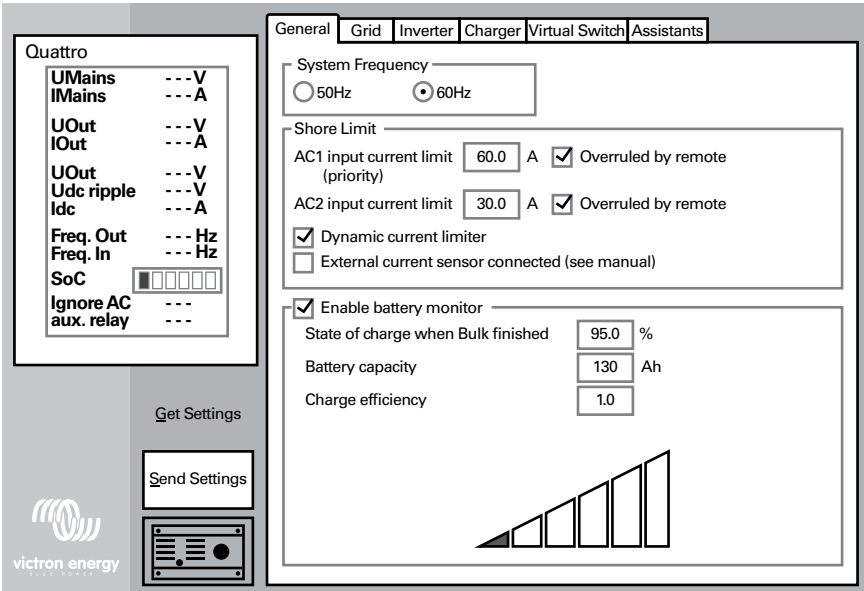

Figure 6. VE Configure 3 Software

5.1.1 Victron Open-loop Inverter-Charger Configuration Procedure

Refer to the latest Discover Battery documentation for battery values and the latest Victron documentation for details on menu navigation and the setup procedure.

1. Set the Discover Lithium batteries to ON and set the inverter to ON.
2. Connect your computer to the Victron GX device or inverter-charger.
3. On the computer, start the VE Configure 3 software configuration tool.
4. Enable and disable parameter values according to the tables below.
5. Send the parameters to the Victron inverter-charger and GX device.
6. Restart the inverter-charger or GX device.

VE Configure > General Tab

General Tab	DLP-GC2-12V	DLP-GC2-24V	DLP-GC2-48V	14-24-2800	14-48-3000	12-48-6650
[AC1] Overruled by remote ⁽¹⁾	Enable	Enable	Enable	Enable	Enable	Enable
[AC2] Overruled by remote ⁽¹⁾	Enable	Enable	Enable	Enable	Enable	Enable
Dynamic Current Limiter	Enable	Enable	Enable	Enable	Enable	Enable
External Current Sensor Connected	Disable	Disable	Disable	Disable	Disable	Disable
Enable battery monitor	Enable	Enable	Enable	Enable	Enable	Enable
SOC when Bulk finished ⁽²⁾	95%	95%	95%	95%	95%	95%
Total battery capacity (per battery installed)	Installed x 120 Ah	Installed x 60 Ah	Installed x 30 Ah	Installed x 110 Ah	Installed x 57 Ah	Installed x 130 Ah
Charge efficiency ⁽²⁾	1.00	1.00	1.00	1.00	1.00	1.00

VE Configure > Inverter Tab

Inverter Tab	DLP-GC2-12V	DLP-GC2-24V	DLP-GC2-48V	14-24-2800	14-48-3000	12-48-6650
DC input low shutdown ⁽³⁾	12.0 V	24.0 V	48.0 V	24.0 V	48.0 V	48.0 V
DC input low restart ⁽⁴⁾	13.4 V	26.8 V	52.8 V	26.8 V	52.8 V	52.8 V
DC input low pre-alarm ⁽⁵⁾	12.4 V	24.8 V	50 V	24.8 V	50 V	50 V
Enable AES ⁽⁶⁾	Disable	Disable	Disable	Disable	Disable	Disable

VE Configure > Charger Tab

Charger Tab	DLP-GC2-12V	DLP-GC2-24V	DLP-GC2-48V	14-24-2800	14-48-3000	12-48-6650
Enable charger	Enable	Enable	Enable	Enable	Enable	Enable
Battery Type (2)	Blank	Blank	Blank	Blank	Blank	Blank
Lithium batteries (2)	Enable	Enable	Enable	Enable	Enable	Enable
Charge curve (2)	Select: Fixed	Select: Fixed	Select: Fixed	Select: Fixed	Select: Fixed	Select: Fixed
Absorption Voltage (2)	13.8 V	27.6 V	55.2 V	27.6 V	55.2 V	55.2 V
Float Voltage (2)	13.6 V	27.2 V	53.6 V	27.2 V	53.6 V	53.6 V
Charge Current	Installed x 120 A	Installed x 60 A	Installed x 30 A	Installed x 110 A	Installed x 57 A	Installed x 130 A
Repeated absorption time (2) (7)	1.0 < 3.0 Hr	1.0 < 3.0 Hr	1.0 < 3.0 Hr	1.0 < 3.0 Hr	1.0 < 3.0 Hr	1.0 < 3.0 Hr
Repeated absorption interval (2)	7.0 Days	7.0 Days	7.0 Days	7.0 Days	7.0 Days	7.0 Days
Absorption time (2) (7)	1.0 < 3.0 Hr	1.0 < 3.0 Hr	1.0 < 3.0 Hr	1.0 < 3.0 Hr	1.0 < 3.0 Hr	1.0 < 3.0 Hr

(1) Enabled is recommended.

(2) Precautionary settings ignored during normal operation and communication with Discover Lithium Battery.

(3) The lowest operating voltage allowed. Increase voltage as required.

(4) Restart voltage after DC input low shutdown. Recommend setting to the minimum value (minimum varies according to the DC Input low shutdown value).

(5) 12.34 V / 24.68 V / 49.5 V value (approximately 10% SOC) will trigger a low battery warning. Increase or decrease as preferred.

(6) 'Enable AES' has no relation to the AES Battery. Refer to Victron manuals for information on the AES setting and function.

(7) The recommended minimum is 1.0 hours. Multiple batteries may require a longer time to achieve a smooth completion of charge.

NOTE

Confirm the Float Voltage after installation of any Victron 'Assistants', and if necessary, set the Float Voltage back to 13.6 V / 27.2 V / 53.6 V.

5.1.2 Victron Open-loop MPPT Charge Controller Configuration Procedure

During normal operation, the MPPT charge characteristics are governed by the Victron GX device in a closed-loop configuration based on data and charge requests provided by the connected Discover Lithium battery.

The Victron MPPT defaults to open-loop (voltage-based) settings when there is a break in communication with LYNK LITE. Therefore, as a precautionary measure, it is recommended to program the Victron MPPT with the correct voltage-based parameters (below) before setting up the system to function in a closed-loop configuration.

The Victron Connect Bluetooth App is used to configure, monitor, and diagnose Victron MPPT Charge Controller products equipped with Bluetooth.

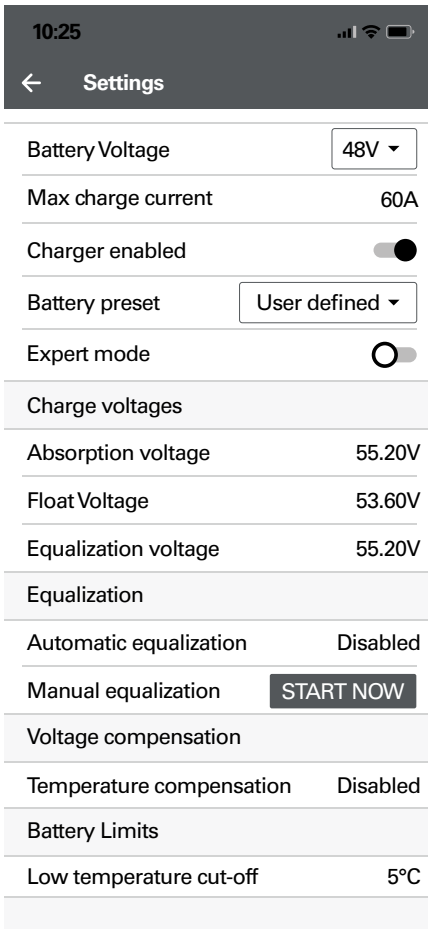

Figure 7. Victron Connect (Bluetooth App)

MPPT Battery Settings Menu	DLP-GC2-12V	DLP-GC2-24V	DLP-GC2-48V	14-24-2800	14-48-3000	12-48-6650
Battery Voltage	12 V	24 V	48 V	24 V	48 V	48 V
Max Current ⁽¹⁾	Installed x 57A	Installed x 130 A	Installed x 30 A	Installed x 110 A	Installed x 57 A	Installed x 130 A
Charger Enabled	Enabled	Enabled	Enabled	Enabled	Enabled	Enabled
Battery Preset	User Defined	User Defined	User Defined	User Defined	User Defined	User Defined
Absorption Voltage	13.8V	27.6V	55.2V	27.6V	55.2V	55.2V
Maximum Absorption Time ⁽²⁾	1.0 < 3.0 Hr	1.0 < 3.0 Hr	1.0 < 3.0 Hr	1.0 < 3.0 Hr	1.0 < 3.0 Hr	1.0 < 3.0 Hr
Float Voltage	13.6V	27.2V	53.6V	27.2V	53.6V	53.6V
Equalization Voltage	13.8V	27.6V	55.2V	27.6V	55.2V	55.2V
Auto Equalization	Disabled	Disabled	Disabled	Disabled	Disabled	Disabled
Temperature Compensation	Disabled	Disabled	Disabled	Disabled	Disabled	Disabled
Low Temperature Cut off	< 0°C (32°F)	< 0°C (32°F)	< 0°C (32°F)	< 0°C (32°F)	< 0°C (32°F)	< 0°C (32°F)

(1) Set to a lower value if necessitated by charger controller size.

(2) Duration of absorption period after the bulk charge interval. The recommended minimum is 1.0 hour. Multiple batteries may require a longer time to achieve a smooth completion of charge.

5.2 Setting Victron as the LYNK LITE Communication Protocol

1. Download and install the current LYNK ACCESS software from the Discover Battery website to get the most up-to-date suite of available protocol configurations.
2. Using a USB cable with a USB micro-B plug, connect the 64-bit Windows 10 computer running LYNK ACCESS software to the USB port on the LYNK LITE.

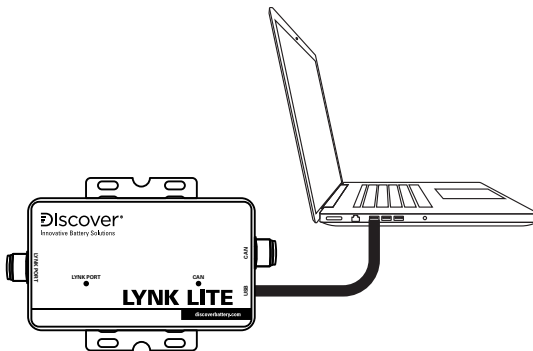

Figure 8. LYNK LITE and LYNK ACCESS USB connection

3. In LYNK ACCESS, confirm that only one LYNK device is connected to the computer.
4. In LYNK ACCESS, select the LYNK tab for optional configuration and settings.
5. Select the blue gear icon in the upper right area of the CAN Settings tile.
6. For the Closed Loop Protocol, select Victron.
7. Confirm CAN outTermination is enabled, and click SAVE to complete the configuration of the LYNK LITE.

NOTICE

Saving configuration changes in LYNK ACCESS automatically forces the LYNK LITE to restart.

5.3 Victron Closed-Loop Configuration

5.3.1 Victron Closed-loop Configuration Procedure

Refer to the latest Discover Battery documentation for battery values and the latest Victron documentation for menu navigation and details on the setup procedure.

1. Set the Discover Lithium batteries to ON and the Victron GX device to ON.
2. Using a touch screen or other user interface of the GX device, set the VE.CAN port and CAN-Bus BMS communication rate to 250 kbit/s.

Device List > Settings > Services > VE.CAN port > CAN-bus profile

- Select **VE.CAN & CAN-bus BMS (250 kbit/s)**

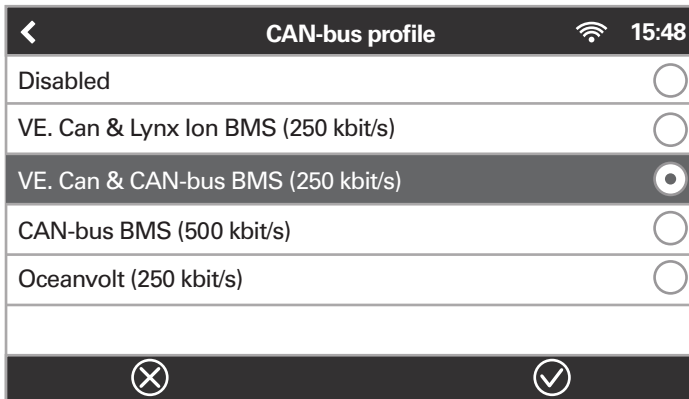
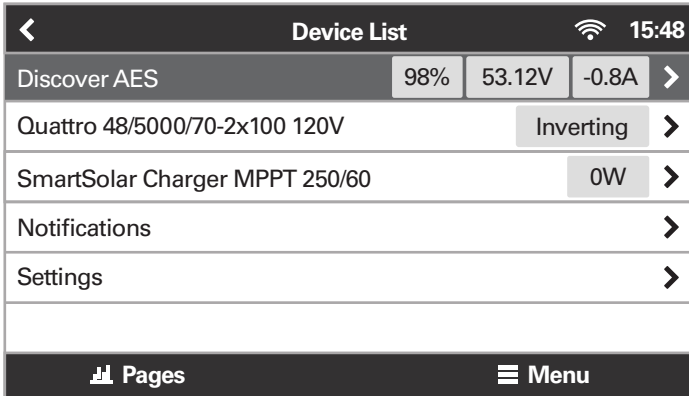

Figure 9. CAN-bus profile

3. Return to the Device List, and the Discover Lithium Battery should now appear as one of the devices.

Device List >



Device List		15:48
Discover AES	98% 53.12V -0.8A	>
Quattro 48/5000/70-2x100 120V	Inverting	>
SmartSolar Charger MPPT 250/60	0W	>
Notifications		>
Settings		>
Pages		Menu

Figure 10. Device List

NOTE

If Discover does not appear on the Device List, confirm that the CAT5 communication cable is a standard patch type, not a cross-over type. Use manufactured cables to avoid bad crimps and reduce the risk of a poor connection.

- To confirm that all batteries in the network are communicating with the Victron system, review the actual battery parameters. If multiple batteries are connected, a single entry shows the total limits of all the batteries.

Device List > Discover [Battery] > Parameters

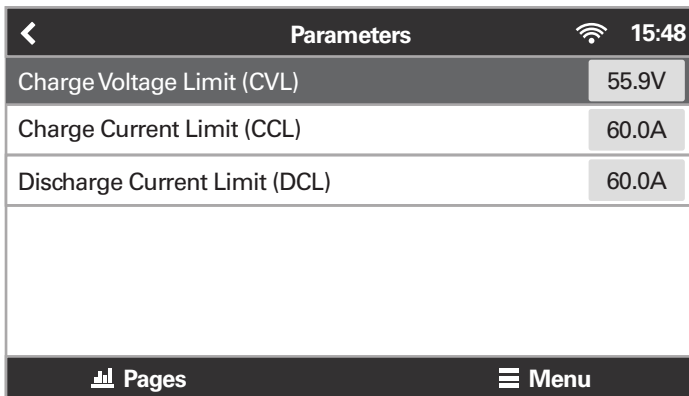

Parameters		15:48
Charge Voltage Limit (CVL)	55.9V	
Charge Current Limit (CCL)	60.0A	
Discharge Current Limit (DCL)	60.0A	
Pages		Menu

5.4 Configurable Closed-Loop Settings

During normal operation, the battery's charge parameter limits are set by the BMS and communicated by the Victron GX device to the inverter-charger and MPPT.

To optimize the performance of a Victron system, manually set the following DVCC menu items using the Victron GX device and reboot the system.

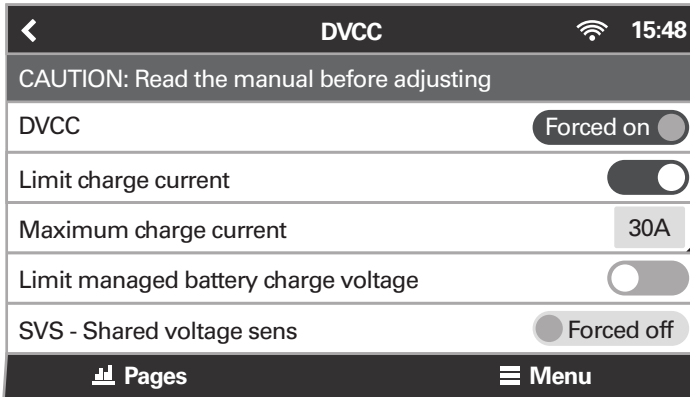

Figure 11. DVCC Menus 1/2

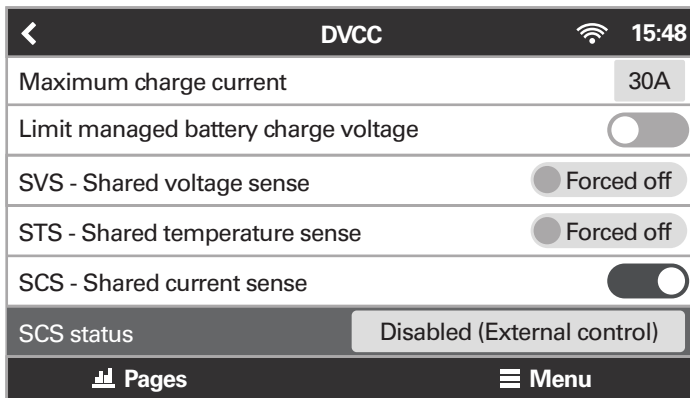

Figure 12. DVCC Menus 2/2

DVCC Menu	Setting
DVCC (Distributed Voltage and Current Control)	Forced on
Limit charge current	ON ⁽¹⁾
Maximum charge current	Installed number of Discover Lithium batteries x their rated Maximum Charger current or a lower value if system curtailment is required.
Limit Managed Battery Charge Voltage	Disable
SVS - Shared voltage sense	Forced off ⁽²⁾
STS - Shared temperature sense	Forced off
SCS - Shared current sense	ON
SCS status	(Displays the current status)

(1) Limit charge current works across the whole system. MPPTs are automatically prioritized over the mains. In cases where the BMS requests a maximum charge current different from the user-configurable setting, it uses the lesser of the two.

(2) SVS should be set to OFF (Victron support has reported conflicts when SVS is ON with a Lithium BMS).

5.4.1 Saving the Configurable Closed-Loop Settings

Device List > Settings> General > Reboot?

After all DVCC menu items have been set, reboot the system.

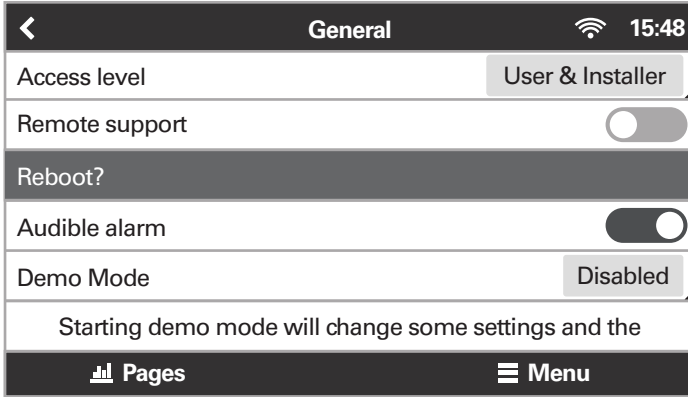

Figure 13. Rebooting the System

NOTE

To avoid conflicting network information and data, do not use a Victron BMV battery monitor when using the LYNK Communication Gateway.

