

Discover[®]

ADVANCED ENERGY

Lithium Ion Battery

Operating Manual

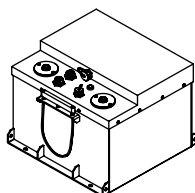

14-12-3000 / 14-24-3000

14-36-3000 / 14-48-3000

1. Safety	2	5.4 Installation	6
1.1 Warnings, Cautions and Notes	2	5.5 Parallel Battery Wiring	7
1.2 General Warning	2	5.6 Commissioning Parallel Systems	8
1.3 Fire Risk	2	6. Networking	8
1.4 Electric Shock Risk	2	6.1 AEBus Network	8
1.5 Chemical Risk	3	6.2 Configuration with Power Conversion and Monitoring Devices	8
1.6 Do's	3	7. Operation	8
1.7 Do Not's	3	7.1 On-Off / Reset	8
1.8 DC Motor and Inductive Load Connection	3	7.2 Charging	8
1.9 Transportation	3	7.3 Open Loop Charge Curve	9
2. Battery Operating Limits	3	7.4 Discharging	10
2.1 Maximum Battery Operating Limits	3	7.5 Storage	10
2.2 Current Protections	4	8. Service & Maintenance	10
2.3 Recommended Battery Operating Limits for High AC Ripple Applications	4	8.1 Warranty Registration	10
3. Design Features & Components	5	8.2 Inspection	10
3.1 Integrated Battery Management System (BMS)	5	8.3 Battery Firmware	11
3.2 Fuse	5	9. Troubleshooting	11
3.3 Protections	5	10. Recycling and Disposal	12
4. Handling	5	11. 14-12-3000 Technical Specifications	13
5. Installation	6	12. 14-24-3000 Technical Specifications	14
5.1 Tools	6	13. 14-36-3000 Technical Specifications	15
5.2 Battery Location	6	14. 14-48-3000 Technical Specifications	16
5.3 Securing Battery	6		

All installations and service should be performed by authorized and qualified personnel only.

1. Safety

1.1 Warnings, Cautions, Notes and Symbols

▲ WARNING
Important information regarding possible personal injury.

▲ CAUTION
Important information regarding possible equipment damage.

▲ NOTE
Additional information concerning important procedures and features of the battery.

1.2 General Warning

▲ CAUTION
It is important to operate the device with care to avoid undesirable consequences.



Do not throw battery in the garbage. Do not dispose in fire.



Use personal protective equipment when working with batteries.



Additional information concerning important procedures and features of the battery. Read all the instructions before installation, operation and maintenance.



This product must be recycled and is made of recycled products.

▲ CAUTION
Do not disassemble or modify the battery. If the battery housing is damaged, do not touch exposed contents.

1.3 Fire Risk

▲ WARNING
Risk of fire - No user serviceable parts inside.

- The AES Battery has a Battery Management System (BMS) with integrated solid state relay to reduce the risk of fire.
- Primary suppression for a lithium battery fire is water, the secondary suppression is CO2 powder and halon.

1.4 Electric Shock Risk

▲ WARNING
For wet and electrically uninsulated working conditions, electric shock risk is high, and can cause injury and death.

Model	Nominal System Voltage	Maximum System Voltage
14-12-3000	12 V	14.6 V
14-24-3000	24 V	29.2 V
14-36-3000	36 V	43.8 V
14-48-3000	48 V	58.4 V

1.5 Chemical Risk

▲ WARNING

Lithium batteries are a chemical risk if misoperated, mishandled or abused.

1.6 Do's

- Do protect terminals from short circuit before, during, and after installation
- Do wear electrically insulated gloves
- Do use electrically insulated tools
- Do wear eye protection
- Do wear safety toe boots / shoes
- Do handle battery carefully
- Do secure battery safely
- Do always assume battery terminals are energized

1.7 Do Not's

- Do not immerse battery in water
- Do not lift or carry the battery during usage or operation
- Do not operate or store battery outside of operating limits
- Do not short circuit battery
- Do not puncture battery
- Do not expose battery to flames, or incinerate
- Do not open battery case or disassemble battery
- Do not wear rings, watches, bracelets or necklaces when handling or working near battery
- Do not drop or crush battery
- Do not lift battery by the terminals or terminal cables
- Do not vibrate battery
- Do not expose battery to water or other fluids
- Do not expose battery to direct sunlight
- Do not dispose of battery
- Do not connect with other types of batteries
- Do not expose battery to high temperatures
- Do not install with other battery types or brands

1.8 DC Motor and Inductive Load Connection

Direct connection to DC motors and other inductive loads, without proper safety protection including motor controllers, and external motor voltage clamping systems (such as high power anti-parallel diodes or braking resistor systems), are subject to high voltage transients that may result in damage to the internal battery pack protection system which may result in unsafe situations. Please consult Discover Battery technical support before directly connecting any motor loads.

1.9 Transportation

If the battery is not installed in equipment, it must be transported in the original package or equivalent.

Batteries are tested according to UN Handbook of Tests and Criteria, part III, sub section 38.3 (ST/SG/AC. 10/11/Rev.5). For transport the batteries belong to category UN3480, Class 9.

2. Battery Operating Limits

2.1 Maximum Battery Operating Limits

The battery should not be operated outside the Maximum Operating Limits, the BMS will open its internal relay and disconnect the battery if any of the following limits are exceeded.

Maximum Operating Limits	14-12-3000	14-24-3000	14-36-3000	14-48-3000
Continuous Charge Current ¹	150 Adc	114 Adc	76 Adc	57 Adc
Continuous Discharge Current ¹	150 Adc	114 Adc	76 Adc	57 Adc
20 Minute Discharge Current ^{1,2}	150 Adc	150 Adc	150 Adc	114 Adc
3 second Peak Current	350 Adc	350 Adc	263 Adc	219 Adc
Charge Voltage	13.6 V	27.2 V	40.8 V	54.4 V
Operating Voltage (Min / Max)	11.2 V/14.6 V	22.4 V/29.2 V	33.6 V/43.8 V	44.8 V/58.4 V
Charge Temperature (Min / Max)	0°C / 45°C (32°F / 113°F)			
Discharge Temperature (Min / Max)	-20°C / 50°C (-4°F / 122°F)			
Storage Temperature (Min / Max)	-10°C / 30°C (-14°F / 86°F)			

¹ Effects of AC Ripple must be taken into consideration when sizing and configuring your system.

² Sustained use above Continuous Current Limits will reduce cycle life.

2.2 Current Protections

The programmed over current protections of the BMS follow the curves seen in the next two figures:

High Current Interrupt Time (100-150%)

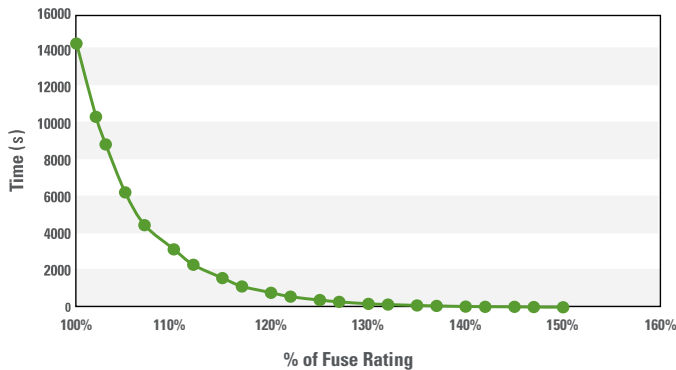

High Current Interrupt Time (200-600%)

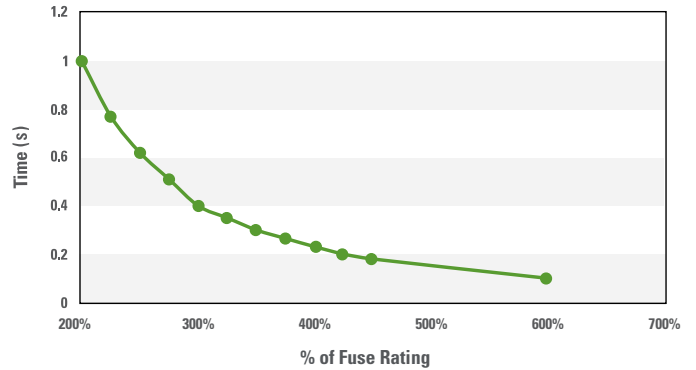

▲ NOTE!

Intentional bypassing of BMS to operate the battery outside maximum and minimum limits voids warranty.

2.3 Recommended Battery Operating Limits for High AC Ripple Applications

The battery maximum operating limits are specified for DC current and voltage and do not account for AC ripple typically caused by frequency conversion electronics such as inverter/chargers. The following operating limits are recommended for these types of systems.

Recommended Operating Settings	14-12-3000	14-24-3000	14-36-3000	14-48-3000
Continuous Charge Current	< 106 A	< 81 A	< 54 A	< 40 A
Continuous Discharge Current	< 106 A	< 81 A	< 54 A	< 40 A
Charge Voltage (Bulk/Absorb)	13.6 V	27.2 V	40.8 V	54.4 V
Charge Voltage (Float)	13.4 V	26.8 V	40.2 V	53.6 V
Low Voltage Disconnect	12 V	24 V	36 V	48 V
Operating Temperature	20°C (68°F)			

3. Design Features and Components

3.1 Integrated Battery Management System (BMS)

Monitors

- Cell module voltages
- Battery voltage
- Battery current
- Battery temperature
- Battery state of charge (SOC)

Module Balancing

- Performs balancing of cell modules

Protection and Operating Limits

- BMS will open its internal relay when maximum operating limits are exceeded
- When the condition returns to its nominal operating range, most protections will be released and reset after 120s

Communication Ports

- Isolated USB and CAN communication

Data Logging

- Logged data is accessed using AES Dashboard software via the USB port (Win64 supported)

3.2 Internal Battery Fuse

The internal battery fuse provides back-up over-current protection. External fusing should be sized correctly to protect the circuit and circuit cabling.

- A blown fuse requires replacement by a qualified installer - contact your Discover installer.

3.3 Protections

The BMS will open the internal relay to protect against operation outside of maximum specifications. During a protection the key LED will flash at 1 Hz. Most protections will be automatically recovered once the condition is cleared with the exception of the low voltage protection.

Protection	Auto Recoverable	Description
Over Voltage	Yes	Protection is triggered when any cell module voltage exceeds the threshold value for 5 seconds. After the voltage falls below the trigger for 120 seconds the protection is cleared.
Under Voltage	No	Protection is triggered when any cell module voltage falls below the threshold value for 5 seconds. The battery will turn itself off after 120s.
High Current	Yes	Protection is triggered when current exceeds the threshold value. The protection will be cleared after 120 seconds.
High Temperature	Yes	Protection is triggered when the battery temperature exceeds the threshold value for 5 seconds. After the temperature falls below the recovery temperature the protection is cleared.
Low Temperature	Yes	Protection is triggered when the battery temperature falls below the threshold value for 5 seconds. After the temperature raises above the recovery temperature the protection is cleared.

4. Handling

▲ WARNING!

Read Safety Section before handling the battery.

- Battery should be set to OFF
- Battery cables should be disconnected
- Battery terminals should be protected
- Battery handle should be used to lift battery
- Battery should be handled by two people or mechanical lift equipment
- Do not lift or carry the battery during usage or operation
- Do not lift the battery with the battery cables

5. Installation

▲ WARNING!

Read Safety Section before installing the battery.

▲ CAUTION!

Do not install AES LiFePO₄ batteries in series. Select the appropriate AES battery model for the voltage of your system.

5.1 Tools

- Insulated tools must be used
- Voltmeter
- Post cleaner and wire brush
- Personal protective equipment

5.2 Battery Location

Locate the batteries close to the power conversion device in order to minimize the length of the battery cables. Care should be taken to ensure adequate clearance above the batteries is maintained for access to both battery and power conversion device connections and disconnects.

Protection from exposure to water, including water sprayed from nozzles, should be ensured.

AES Battery performance and service life will be optimized when they are operated in an ambient temperature of 15°C to 25°C (59°F to 77°F). Care should be taken to ensure that the battery's temperature is > 0°C (32°F) during charging.

5.3 Securing Battery

- Battery can be strapped in place with non-conductive nylon straps
- Battery may have hold down brackets at the base of the battery

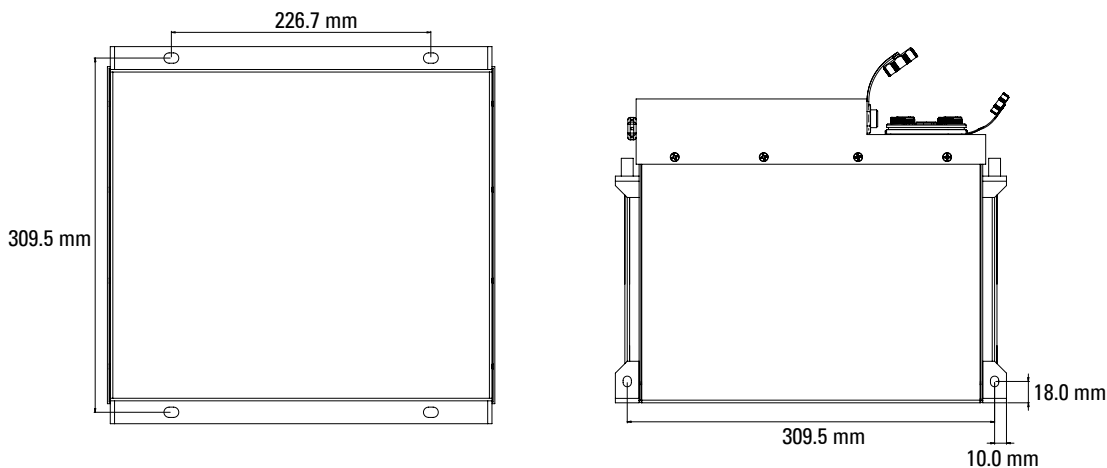

5.4 Installation

Battery cables must be sized to the specifications required by the inverter charger, and must be installed in accordance with the standards set by the authority having local jurisdiction. Do not use or install a battery temperature sensor.

- Confirm that battery is set to OFF
- If the battery circuit has a disconnect - open the disconnect to isolate battery
- Cable connection points should always be kept clean
- Broken, frayed, brittle, kinked or cut cables should never be used
- Secure the new battery - be careful not to ground the terminals to any metal mounting, fixture, or body part
- Connect battery cables - connect the ground cable last to avoid sparking
- Terminals are button-type, M8 female - recommended torque is 9.0 Nm (6.64 ft-lb)
- Inspect the battery cables to ensure they have not been installed in reverse polarity
- If the battery circuit has a disconnect - close disconnect to reconnect the battery
- Set the battery to ON

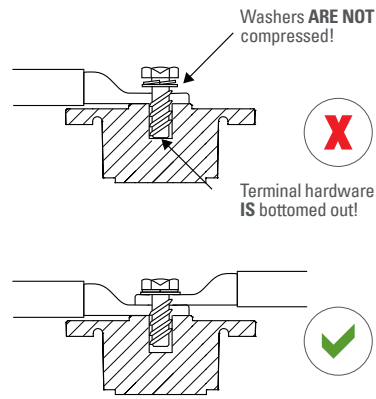
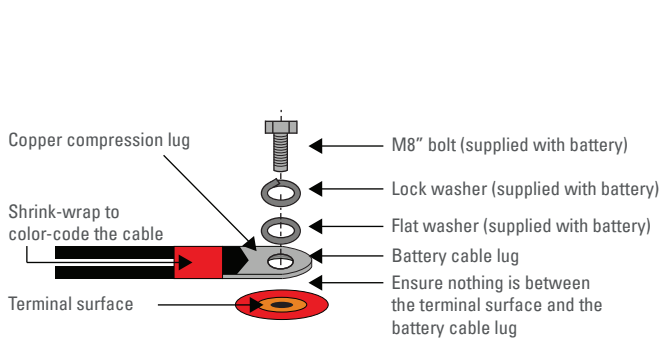

▲ NOTE!
All cable ends must be connected to battery terminals without any washers between terminal bushings and cable ends.

Terminal burnout is caused by:

- Discharge currents exceeding allowable limits
- Improper cable installation
- Improper cable sizing
- Improper terminal torque

▲ NOTE!
Without exception, product experiencing terminal burn out will not be warranted.

5.5 Parallel Battery Wiring

To ensure proper balancing and load sharing between parallel batteries refer to the wiring diagram below. Lithium batteries are very sensitive to voltage and undersized battery cables will impede battery and system performance. The thickness (cross section) of cable used should exceed the recommended minimum for the inverter charger installation whenever possible.

Five or more batteries in parallel should be installed using a busbar configuration. In a busbar configuration all battery cable sets should be the same length regardless of the battery's proximity to the busbar (or combiner box). Actual wiring requirements may vary. Consult with the authority having local jurisdiction.

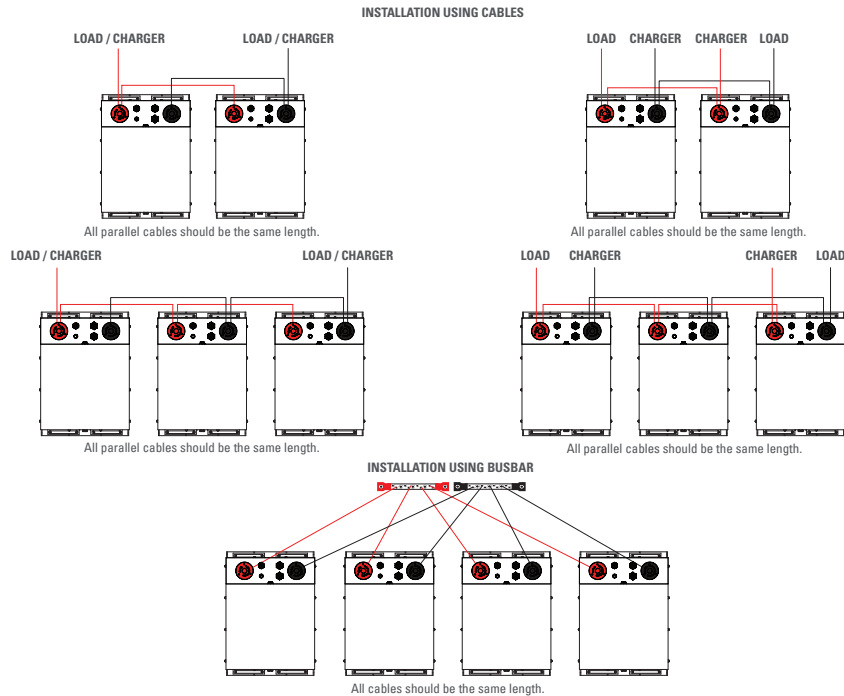

5.6 Commissioning Parallel Systems

When commissioning a system with parallel batteries ensure that all batteries are set to ON before the power electronics are energized.

6. Networking

6.1 AE Bus Network

The AE Bus is utilized by all networked AES batteries to coordinate all voltage, temperature, and current data. Network Terminators are required for proper functioning of the AE Bus network. Care should be taken to ensure they are installed.

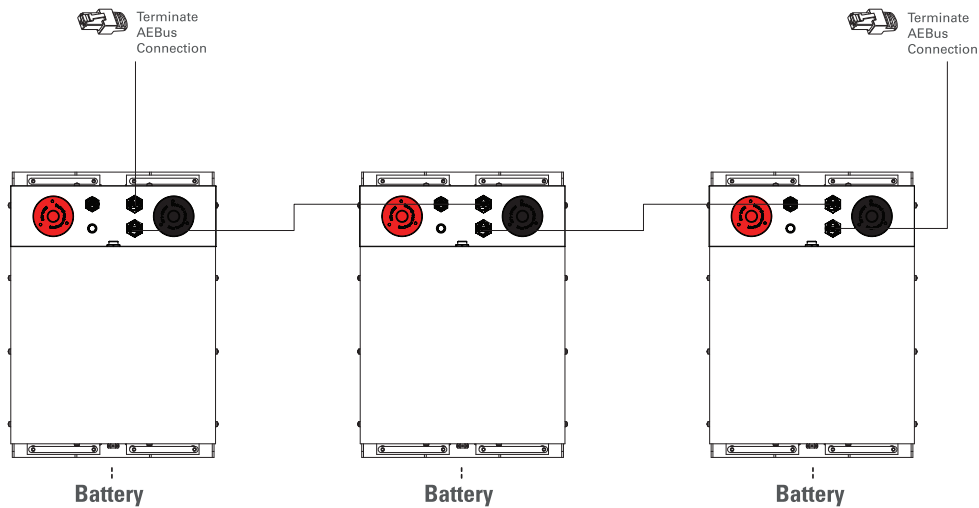

6.2 Configuration with Power Conversion and Monitoring Devices

AES batteries must be set up to work with the Power Conversion devices in either an Open Loop or Closed Loop configuration. The charge and discharge settings in a Open Loop configuration are set up through the controller for the Power Conversion device at the time of installation. In a Closed Loop configuration, charge and discharge settings are dynamically controlled by the BMS of the AES Battery over a connection with the Power Conversion device network. Charge sources with compliant J1939 Canbus communications can be used directly with AEBus. All other Closed Loop communication with a Power Conversion device network requires the use of a LYNK Gateway Communication device available from Discover Battery.

For Closed Loop and Open Loop configuration details please refer to the appropriate Application Note for your Power Conversion device available from the Discoverbattery.com website, or contact your Discover Battery provider for assistance.

7. Operation

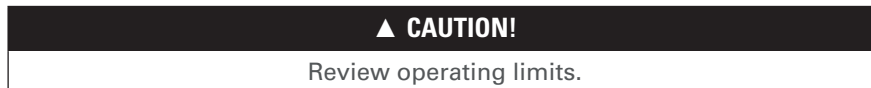

7.1 On–Off / Reset

- To set the battery to ON momentarily press the button - the LED will illuminate
- To set the battery to OFF momentarily press the button - the LED will darken



7.2 Charging

Before charging the battery make sure to read and understand the instructions that come with the Power Conversion device. Never attempt to charge a battery without first reviewing and understanding the instructions for the Power Conversion device being used. Do not use or install a battery temperature sensor.

▲ CAUTION!

Always make sure the charge curve parameters of the charging device are set to meet the charging requirements of the battery; never charge a visibly damaged battery; never charge a frozen battery.

1. Connect the Power Conversion device's charger leads to the battery.
2. Ensure the charger and battery side connections are tight.
3. Set the charger to ON
4. Set the battery to ON

▲ CAUTION!

NOT ALL CHARGERS ARE CAPABLE OF CHARGING LITHIUM BATTERIES
CONFIRM that your chosen charger is incapable of producing transient spikes that exceed the published terminal voltage limits for the battery.

Spikes are fast, short duration electrical transients in voltage (voltage spikes), current (current spikes), or transferred energy (energy spikes) in an electrical circuit. Voltage spikes usually happen when the AC/DC adapter is plugged in, or charge current is cut off quickly. Multi voltage chargers are constructed using transformers that may be capable of producing spikes that exceed the maximum ratings of the Discover AES Battery. You must ensure that the charger being supplied:

- Meets the recommended charge curve
- Incapable of exceeding Discover's maximum terminal voltages

7.3 Open Loop Charge Curve

1. Charge at constant current to 3.4V per cell module (Bulk).
2. Maintain constant voltage 3.4V per cell module (Absorption).
3. Terminate when charge current drops below 2A.
4. Optional Float at 3.35V per cell module (Float).

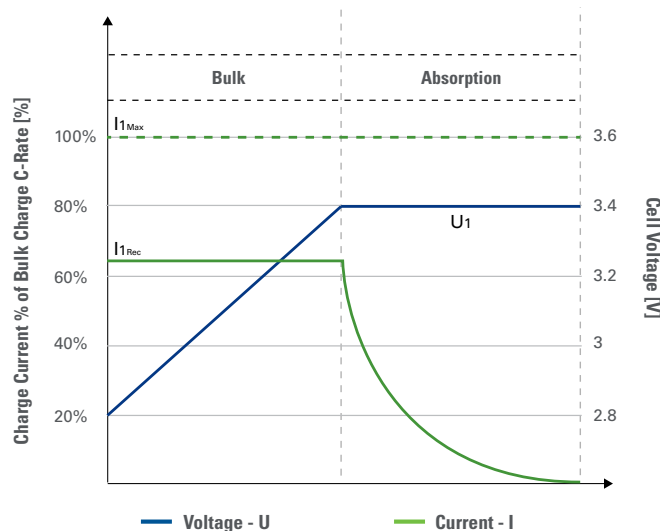

▲ CAUTION!
Do not charge battery higher than 3.4 V per cell module.

▲ NOTE!
Recommended charge current is 0.5C

Model	Cell Modules in Series	Bulk Current	Absorption Voltage	Termination Charge Current
14-12-3000	4 S	150 Adc maximum	13.6 V	$I_2 \leq 2 A$
14-24-3000	8 S	114 Adc maximum	27.2 V	
14-36-3000	12 S	76 Adc maximum	40.8 V	
14-48-3000	16 S	57 Adc maximum	54.4 V	

7.4 Discharging

- Set the battery to ON
- Set the load to ON
- Recommended low voltage cut off: 12 V | 24 V | 36 V | 48 V

▲ NOTE!
Do not discharge battery below the recommended minimum operating voltages.

▲ NOTE!
Do not discharge battery at rates greater than recommended operating currents.

7.5 Storage

Systems should be turned off and stored out of direct sunlight in compliance with the following temperature conditions:

Recommended Minimum	-10°C / 14°F
Recommended Maximum	30°C / 86°F

Batteries should never be stored at 100% SOC. Store batteries at approximately 80% SOC and checked monthly to ensure the SOC does not fall below 20%. At 20% SOC the battery will self discharge in approximately 2 months.

▲ CAUTION!
Do not store a discharged battery. Recharge battery after every use. Batteries that have self-discharged to a severely discharge state are not recoverable.

8. Service & Maintenance

8.1 Warranty Registration

To register your product you will need the serial number of the battery. Visit discoverbattery.com for registration details.

8.2 Inspection

Batteries should be carefully inspected on a regular basis in order to detect and correct potential problems before they do harm. This routine should be started when the batteries are first received.

- Inspect for cracks in the battery casing
- Check battery terminals and connections to make sure they are clean, free of dirt, fluids and corrosion

- All battery cables and their connections should be tight, intact, and NOT broken or frayed
- Replace any damaged batteries
- Replace any damaged cables
- Ensure correct torque is used for the terminal bolts

8.3 Battery Firmware

Consult the Discoverbattery.com website for the latest battery firmware versions. If a battery firmware update is require, ensure this is done by a qualified and authorized person using the AES Dashboard software tool.

9. Troubleshooting

If you have not already, read the manual. Most troubleshooting needs arise from misuse, or a failure to understand installation and operating instructions.

As soon as possible, record the condition of the system at the time the problem occurred so you can provide details to help aid in troubleshooting.

Download the separate data log from each battery using the AES Dashboard software tool and have the file(s) ready to share with technical support.

9.1 Check the Fuse

Check the fuse. If the fuse is blown (open) it requires replacement.

9.2 Review Voltage

Was the battery stored or left for a long period of time at low voltage? The battery may be self discharged and damaged beyond repair.

Was the battery charged above BMS protection voltage? The BMS will have likely disconnected the battery. The battery needs to be left to rest until the high voltage has dissipated. The battery will operate again when the BMS detects that voltage is within safe operating parameters for at least 120s. Note that the charging device's voltage needs to be reduced in order not to repeat this fault.

Was the battery discharged below low voltage cut-Off? The BMS has likely disconnected battery. The BMS will not reconnect the battery after a low voltage disconnection. Disconnect all loads, set the battery to ON and then charge the battery.

9.3 Review Temperature

Was the battery operated above BMS protection temperature? The BMS will have likely disconnected the battery. The battery needs to be moved to a cooler environment and left to rest until the high internal temperature has dissipated. The battery will operate again when the BMS detects that internal temperature is within safe operating parameters for at least 120s.

Was the battery operated at high current in a moderate to high temperature? The BMS will have likely disconnected the battery. High current operation can increase the internal battery temperature above ambient temperature.

Was the battery operated below BMS protection temperature? The battery needs to be moved to a warmer environment and left to rest until the low internal temperature increases. The battery will operate again when the BMS detects that internal temperature is within safe operating parameters for at least 120s.

9.4 Review Current

Did the BMS protect against over current when an inverter was turned ON? A large capacitor bank in the inverter likely tried to draw amps in excess of the battery's peak power rating and the BMS has disconnected the battery. Increasing the number of batteries in the battery bank will help support a high peak amp draw, or surge current.

Did the BMS protect against over current when a motor was turned ON? The initial surge current required to start the motor is likely in excess of the battery's peak power rating and the BMS has disconnected the battery. Increasing the number of batteries in the battery bank will help support a high peak amp draw, or surge curreect level.

Is the battery bank undersized as compared to the peak surge requirements of the system? Increasing the number of batteries in the battery bank will help support a high peak amp draw, or surge current.

9.5 Reverse Polarity

Was the battery exposed to reverse polarity? If the battery cables were attached in reverse polarity the BMS will likely be damaged beyond repair and will require replacement. Contact your dealer and have a qualified and authorized person replace the BMS.

9.6 Symptom Analysis

Low or zero volts across the terminals when battery is set to ON.	The battery may be fully discharged	Charge the battery
	The battery's internal fuse may have blown (open)	Have the battery's internal fuse replaced
	The BMS may have engaged low voltage protection	1) Remove all loads from the battery 2) Set the battery to ON (toggle OFF and then ON) 3) Charge the battery
Voltage drops abruptly while in use after appearing to be constant	The battery may be fully discharged	Charge the battery
	The BMS may have engaged over current protection**	Reduce the current draw on the battery
	The BMS may have engaged over temperature protection	Reduce the internal battery temperature by reducing ambient temperature and / or reduce high current draw on the battery
	The BMS may have engaged under temperature protection	Increase the internal battery temperature by increasing the ambient temperature
	The battery's internal fuse may have blown (open)	1) Have the battery's internal fuse replaced 2) Reduce load in-rush currents 3) Increase battery bank Ah capacity (parallel operation)
Charge current suddenly drops to zero while connected to a charger	The charge current may be too high, and the BMS has engage over current protection	Reduce the charge current
	The temperature of the battery cells is below 0°C (32°F), and the BMS has engaged low temperature protection	Increase the internal battery temperature by increasing the ambient temperature
	The battery cell temperature may be over the operating limit, and the BMS has engaged high battery temperature protection	Reduce the internal battery temperature by reducing ambient temperature and / or reduce high current draw on the battery
	The battery cells may be out of balance	Apply a float charge for 48 hours to balance the battery cells
The battery does not deliver the expected Ah (capacity)	The battery cells may be out of balance	Apply a float charge for 48 hours to balance the battery cells
	The battery may have reached the end of its useful service life	Replace the battery
	The battery may have over heated due to high ambient temperatures and / or high current	Reduce the internal battery temperature by reducing ambient temperature and / or reduce high current draw on the battery

** Over current protection for extremely high current inrush (inverter startup, motor startup) can be engage in under 1ms. A digital ammeter will likely not be fast enough to measure this type of current.

10. Recycling and Disposal

Batteries must not be mixed with domestic or industrial waste. Discover AES batteries are recyclable and must be processed through a recognized recycling agency or dealer. Please contact Discover or your servicing dealer for details.



12. 14-12-3000 TECHNICAL SPECIFICATIONS

Electrical Specifications	
Nominal Voltage	12.8 V
Charge Voltage	13.6 V
Maximum Voltage	14.6 V
Minimum Voltage	11.2 V
Nominal Capacity	228 Ah
Nominal Energy	2918 Wh
Max Continuous Current	150 Adc
20 Minute Discharge Current	150 Adc
Fuse	200 A Internal Fuse. Provides backup over-current protection
Cell Chemistry	LiFePO ₄
Cell Modules	4S 60P
Self-Discharge 25°C / 77°F	< 3% per month (battery off @50% SOC)

Protection Limits	
OverTemperature - Protection	> 60°C/140°F for 5s
OverTemperature - Recovery	< 50°C/122°F
LowTemperature - Discharge Protection	< -20°C/-4°F for 5s
LowTemperature - Charge Protection	< 0°C/32°F for 5s
Over Voltage Protection	> 3.65 V in any cell module for 5s
Over Voltage Recovery	<3.65 V for 120s
Under Voltage Protection	< 2.5 V in any cell module for 5s
Under Voltage Recovery	>2.5 V for 120s
Over Current Protection	> 150 Adc
Over Current Recovery	120s

Mechanical Specifications	
Battery Model	900-0044
Battery Dimensions (HxWxD)	256 x 339 x 330 mm
Battery Weight	40 kg
Shipping Dimensions (HxWxD)	470 x 430 x 390 mm
Shipping Weight	45 kg
Terminal	M8
Terminal Hardware	M8 Stainless Steel Bolt, Flat Washer, Lock Washer (Supplied)
Terminal Torque	9.0 Nm +/- 3
Case Material	Powder Coated Cold Rolled Steel
Enclosure IP Rating	IP 55
Charge Temperature Range	0°C/45°C (32°F/113°F)
Discharge Temperature Range	-20°C/50°C (-4°F/122°F)

Storage Temperature Range	-20°C/45°C (-4°F/113°F)
Operational Specifications	
Battery Management System (BMS) Field Replaceable	Integrated, with Solid State Relay (SSR)
Cell Balancing	Passive balancing when Cell Voltage > 3.35 V
Non-Volatile Memory	Yes
Lifetime Logged Data	<ul style="list-style-type: none"> • Time • High/low average cell module voltage • Balancing, Protection and Relay State • Battery SOC, Current, Voltage, Temperature • Charge Energy In/Out
Communication Ports	<ul style="list-style-type: none"> • Isolated USB • Isolated CAN (AEBus)
Communication Connectors	USB Type Mini-B Female RJ45 Jack x2

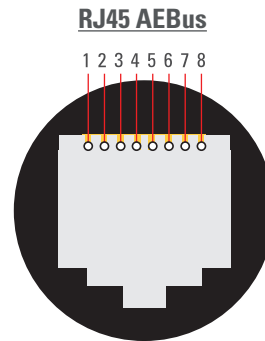

Pin 1	AEBus +12 V
Pin 2	AEBus +12 V
Pin 3	AEBus GND
Pin 4	AEBus CAN Low
Pin 5	AEBus CAN High
Pin 6	AEBus +5V
Pin 7	AEBus GND
Pin 8	AEBus GND

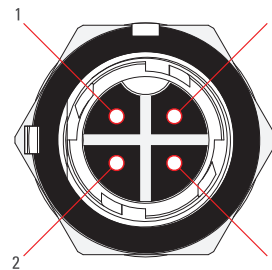

Pin 1	LED +V
Pin 2	LED GND
Pin 3	Key Switch
Pin 4	Key +

Regulatory Approvals	
	UN 38.3 IEC 62619 UL 1973

UN38.3 PASSED
TRANSPORT SAFETY CERTIFIED



13. 14-24-3000 TECHNICAL SPECIFICATIONS

Electrical Specifications	
Nominal Voltage	25.6 V
Charge Voltage	27.2 V
Maximum Voltage	29.2 V
Minimum Voltage	22.4 V
Nominal Capacity	114 Ah
Nominal Energy	2918 Wh
Max Continuous Current	114 Adc
20 Minute Discharge Current	150 Adc
Fuse	200 A Internal Fuse. Provides backup over-current protection
Cell Chemistry	LiFePO ₄
Cell Modules	8S 30P
Self-Discharge 25°C / 77°F	< 3% per month (battery off @50% SOC)

Protection Limits	
OverTemperature - Protection	> 60°C/140°F for 5s
OverTemperature - Recovery	< 50°C/122°F
LowTemperature - Discharge Protection	< -20°C/-4°F for 5s
LowTemperature - Charge Protection	< 0°C/32°F for 5s
Over Voltage Protection	> 3.65 V in any cell module for 5s
Over Voltage Recovery	<3.65 V for 120s
Under Voltage Protection	< 2.5 V in any cell module for 5s
Under Voltage Recovery	>2.5 V for 120s
Over Current Protection	> 150 Adc
Over Current Recovery	120s

Mechanical Specifications	
Battery Model	900-0043
Battery Dimensions (HxWxD)	256 x 339 x 330 mm
Battery Weight	40 kg
Shipping Dimensions (HxWxD)	470 x 430 x 390 mm
Shipping Weight	45 kg
Terminal	M8
Terminal Hardware	M8 Stainless Steel Bolt, Flat Washer, Lock Washer (Supplied)
Terminal Torque	9.0 Nm +/- 3
Case Material	Powder Coated Cold Rolled Steel
Enclosure IP Rating	IP 55
Charge Temperature Range	0°C/45°C (32°F/113°F)
Discharge Temperature Range	-20°C/50°C (-4°F/122°F)
Storage Temperature Range	-10°C/30°C (14°F/86°F)

Operational Specifications	
Battery Management System (BMS) Field Replaceable	Integrated, with Solid State Relay (SSR)
Cell Balancing	Passive balancing when Cell Voltage > 3.35 V
Non-Volatile Memory	Yes
Lifetime Logged Data	<ul style="list-style-type: none"> • Time • High/low average cell module voltage • Balancing, Protection and Relay State • Battery SOC, Current, Voltage, Temperature • Charge Energy In/Out
Communication Ports	<ul style="list-style-type: none"> • Isolated USB • Isolated CAN (AEBus)
Communication Connectors	USB Type Mini-B Female RJ45 Jack x2

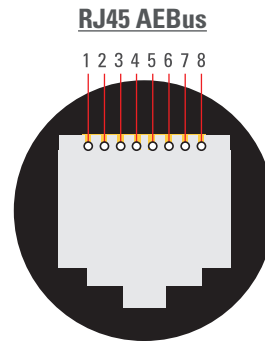

Pin 1	AEBus +12 V
Pin 2	AEBus +12 V
Pin 3	AEBus GND
Pin 4	AEBus CAN Low
Pin 5	AEBus CAN High
Pin 6	AEBus +5V
Pin 7	AEBus GND
Pin 8	AEBus GND

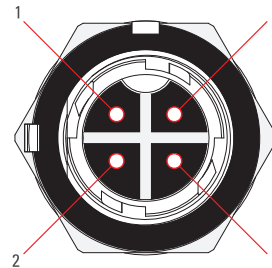

Pin 1	LED +V
Pin 2	LED GND
Pin 3	Key Switch
Pin 4	Key +

Regulatory Approvals	
	UN 38.3 IEC 62619 UL 1973

UN38.3 PASSED
TRANSPORT SAFETY CERTIFIED



14. 14-36-3000 TECHNICAL SPECIFICATIONS

Electrical Specifications	
Nominal Voltage	38.4 V
Charge Voltage	40.8 V
Maximum Voltage	43.8 V
Minimum Voltage	33.6 V
Nominal Capacity	76 Ah
Nominal Energy	2918 Wh
Max Continuous Current	76 Adc
20 Minute Discharge Current	150 Adc
Fuse	150 A Internal Fuse. Provides backup over-current protection
Cell Chemistry	LiFePO ₄
Cell Modules	12S 20P
Self-Discharge 25°C / 77°F	< 3% per month (battery off @50% SOC)

Protection Limits	
OverTemperature - Protection	> 60°C/140°F for 5s
OverTemperature - Recovery	< 50°C/122°F
LowTemperature - Discharge Protection	< -20°C/-4°F for 5s
LowTemperature - Charge Protection	< 0°C/32°F for 5s
Over Voltage Protection	> 3.65 V in any cell module for 5s
Over Voltage Recovery	<3.65 V for 120s
Under Voltage Protection	< 2.5 V in any cell module for 5s
Under Voltage Recovery	>2.5 V for 120s
Over Current Protection	> 150 Adc
Over Current Recovery	120s

Mechanical Specifications	
Battery Model	900-0042
Battery Dimensions (HxWxD)	256 x 339 x 330 mm
Battery Weight	40 kg
Shipping Dimensions (HxWxD)	470 x 430 x 390 mm
Shipping Weight	45 kg
Terminal	M8
Terminal Hardware	M8 Stainless Steel Bolt, Flat Washer, Lock Washer (Supplied)
Terminal Torque	9.0 Nm +/- 3
Case Material	Powder Coated Cold Rolled Steel
Enclosure IP Rating	IP 55
Charge Temperature Range	0°C/45°C (32°F/113°F)

Discharge Temperature Range	-20°C/50°C (-4°F/122°F)
Storage Temperature Range	-10°C/30°C (14°F/86°F)
Operational Specifications	
Battery Management System (BMS) Field Replaceable	Integrated, with Solid State Relay (SSR)
Cell Balancing	Passive balancing when Cell Voltage > 3.35 V
Non-Volatile Memory	Yes
Lifetime Logged Data	<ul style="list-style-type: none"> •Time •High/low average cell module voltage •Balancing, Protection and Relay State •Battery SOC, Current, Voltage, Temperature •Charge Energy In/Out
Communication Ports	<ul style="list-style-type: none"> • Isolated USB • Isolated CAN (AEBus)
Communication Connectors	USB Type Mini-B Female RJ45 Jack x2

RJ45 AEBus

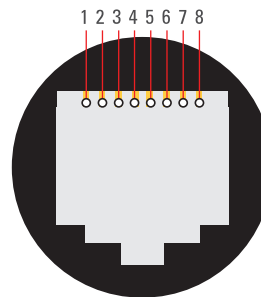

Pin 1	AEBus +12 V
Pin 2	AEBus +12 V
Pin 3	AEBus GND
Pin 4	AEBus CAN Low
Pin 5	AEBus CAN High
Pin 6	AEBus +5V
Pin 7	AEBus GND
Pin 8	AEBus GND

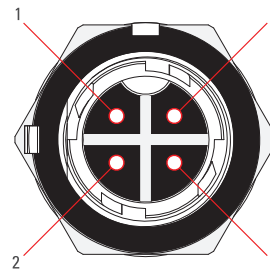

Pin 1	LED +V
Pin 2	LED GND
Pin 3	Key Switch
Pin 4	Key +

Regulatory Approvals	
	UN 38.3 IEC 62619 UL 1973

UN38.3 PASSED
TRANSPORT SAFETY CERTIFIED



15. 14-48-3000 TECHNICAL SPECIFICATIONS

Electrical Specifications	
Nominal Voltage	51.2 V
Charge Voltage	54.4 V
Maximum Voltage	58.4 V
Minimum Voltage	44.8 V
Nominal Capacity	57 Ah
Nominal Energy	2918 Wh
Max Charge Current	57 Adc
20 Minute Discharge Current	114 Adc
Fuse	125 A Internal Fuse. Provides backup over-current protection
Cell Chemistry	LiFePO ₄
Cell Modules	16S 15P
Self-Discharge 25°C / 77°F	< 3% per month (battery off @50% SOC)

Protection Limits	
OverTemperature - Protection	> 60°C/140°F for 5s
OverTemperature - Recovery	< 50°C/122°F
LowTemperature - Discharge Protection	< -20°C/-4°F for 5s
LowTemperature - Charge Protection	< -0°C/-32°F for 5s
Over Voltage Protection	> 3.65V in any cell module for 5s
Over Voltage Recovery	<3.65 V for 120s
Under Voltage Protection	< 2.5 V in any cell module for 5s
Under Voltage Recovery	>2.5 V for 120s
Over Current Protection	> 150 Adc
Over Current Recovery	120s

Mechanical Specifications	
Battery Model	900-0041
Battery Dimensions (HxWxD)	256 x 339 x 330 mm
Battery Weight	40 kg
Shipping Dimensions (HxWxD)	470 x 430 x 390 mm
Shipping Weight	45 kg
Terminal	M8
Terminal Hardware	M8 Stainless Steel Bolt, Flat Washer, Lock Washer (Supplied)
Terminal Torque	9.0 Nm +/- 3
Case Material	Powder Coated Cold Rolled Steel
Enclosure IP Rating	IP 55
Charge Temperature Range	0°C/45°C (32°F/113°F)
Discharge Temperature Range	-20°C/50°C (-4°F/122°F)

Storage Temperature Range	-10°C/30°C (14°F/86°F)
Operational Specifications	
Battery Management System (BMS) Field Replaceable	Integrated, with Solid State Relay (SSR)
Cell Balancing	Passive balancing when Cell Voltage > 3.35 V
Non-Volatile Memory	Yes
Lifetime Logged Data	<ul style="list-style-type: none"> • Time • High/low average cell module voltage • Balancing, Protection and Relay State • Battery SOC, Current, Voltage, Temperature • Charge Energy In/Out
Communication Ports	<ul style="list-style-type: none"> • Isolated USB • Isolated CAN (AEBus)
Communication Connectors	USB Type Mini-B Female RJ45 Jack x2

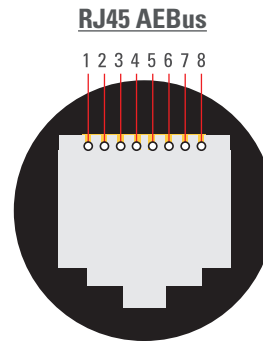

Pin 1	AEBus +12 V
Pin 2	AEBus +12 V
Pin 3	AEBus GND
Pin 4	AEBus CAN Low
Pin 5	AEBus CAN High
Pin 6	AEBus +5V
Pin 7	AEBus GND
Pin 8	AEBus GND

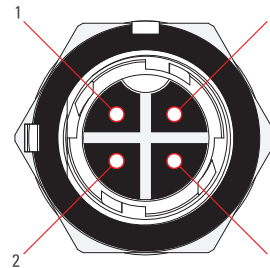

Pin 1	LED +V
Pin 2	LED GND
Pin 3	Key Switch
Pin 4	Key +

Regulatory Approvals	
	UN 38.3 IEC 62619 UL 1973

UN38.3 PASSED
TRANSPORT SAFETY CERTIFIED

